

Article number: 20163B30502SW

Description: E+G

Base plate clamp GN163-B30-50-2-SW

Measures

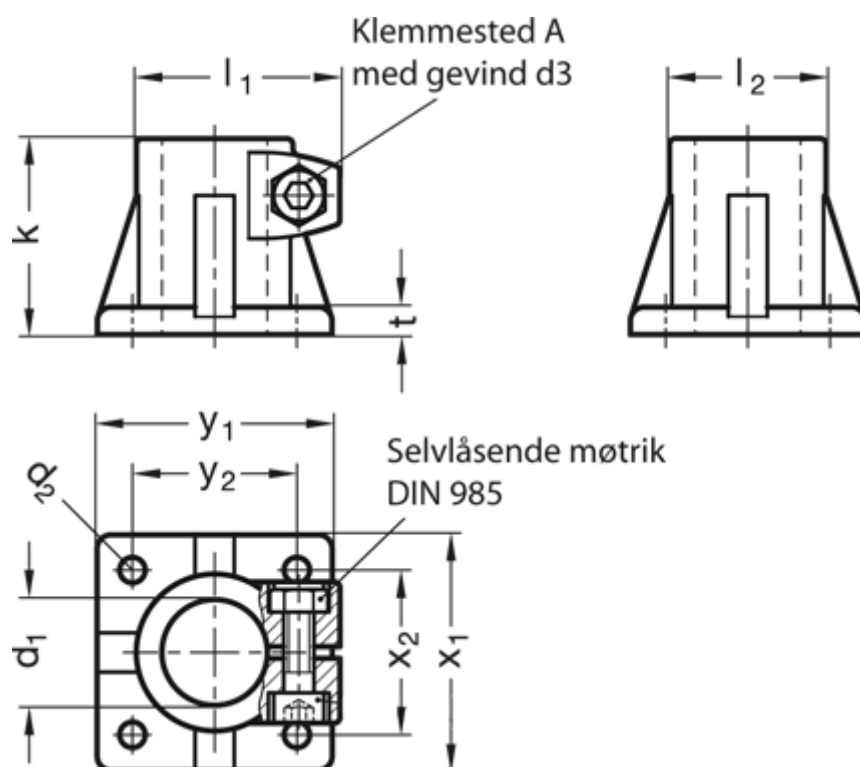

Adjustable clamp lever = GN 911-M8-32 have to be ordered separately

d1	= B30
d2	= 6.5
d3	= M 8
k	= 50
l1	= 52.0
l2	= 40
t	= 7

x1 = 60

x2 = 42

y1 = 60

y2 = 42